

High-capacity Nutdriver units SEM-Series

with automatic feeding, developed
for series production (automation)

**STÖGER
technology put
to your use!**

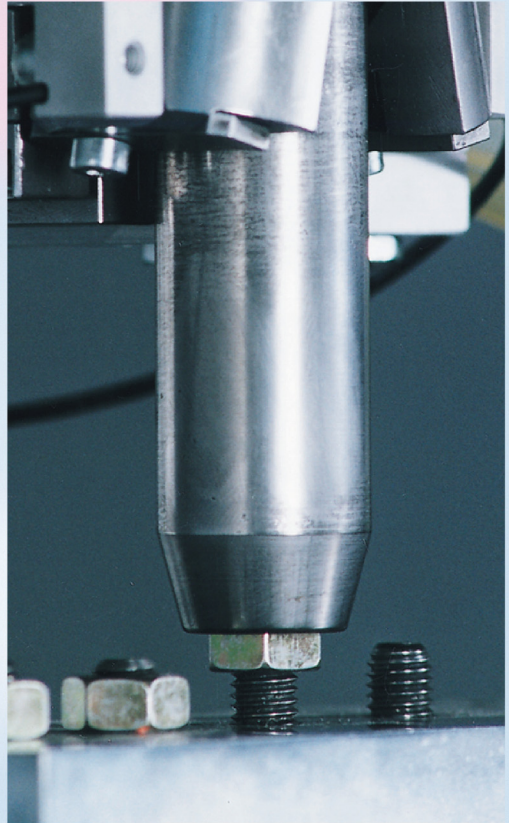

Cycle times / Operating costs

Automatic feeding

- Fully automatic operation - lower operating costs
- Semi-automatic operation - the operator can carry out preparation work during running. Doubling of output is possible.

Project support

We help you plan your project

- Consultation in system decisions per telephone or with a visit
- Price guides for your calculations
- 3D data for your presentation

Investment

Quality consistence that you determine

- The monitoring of the fitting process is your decision - as extensive as necessary, as economical as possible.

You decide the package

- A ready-to-use system with extensive STÖGER guarantee
- STÖGER components for integration in your system

Layout

Version 1

Controlled centering pin

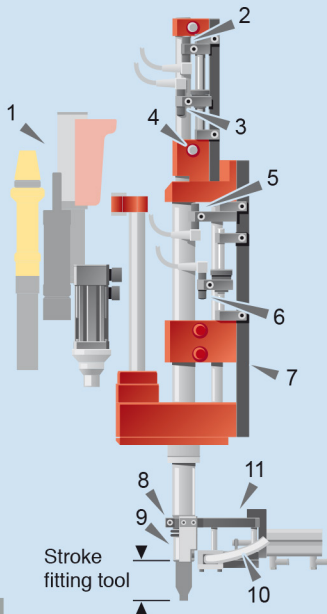
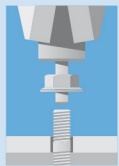

Stroke fitting tool

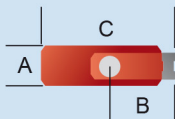
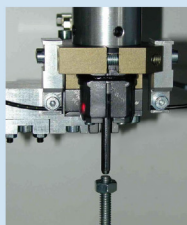

Version 2

Spring-loaded centering pin

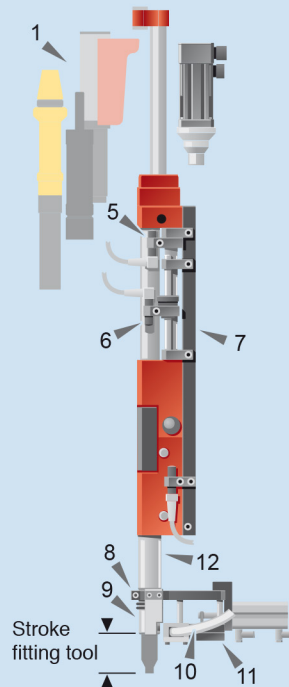

Stroke fitting tool



- 1 Motor (electric, pneumatic or free choice (see SES / SVS))
- 2 Centering pin return sensor
- 3 Centering pin depth sensor
- 4 Centering pin stroke adjustment
- 5 Return sensor (start position)
- 6 Depth sensor
- 7 Mounting plate

- 8 Locking screw to position nut-driving head
- 9 Centering jaws
- 10 Feed tube
- 11 Nut feeding assembly
- 12 Vacuum connection (if longer stroke or vacuum tool a requirement)

Technical data	SEM 1601	SEM 2001	SEM 2501	SEM 3201
Nut max. thread	M4	M6	M8	M12
Torque (Nm)	0,03-0,06	0,2-4,5	0,5-12,0	1,0-45,0
Stroke	15/30	25/50	35/70	50/100

Dimensions	SEM 1601	SEM 2001	SEM 2501	SEM 3201
A (mm)	-	-	-	52
B (mm)	-	-	-	82
C (mm)	-	-	-	189
D (mm)	25,0	30,0	35,0	43,0
E (mm)	42,0	58,0	68,0	86,0

Our advantages

- Rotation of nutdriving head infinitely variable
- Compact design (short, small diameter, low weight)
- Variable mounting position

Easy servicing

- Simple socket change in operating position (without tools)
- Change does not require space between tool and workpiece

Control functions

- Torque
- Fitting depth
- Start position
- Nut-loading control
- Special requirements



Selection of nut types

Package

- Supplied also as separate components

Nutdriver

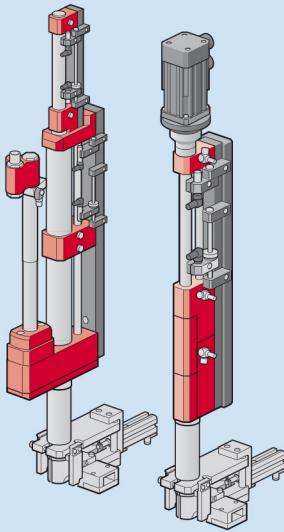

Feeder unit

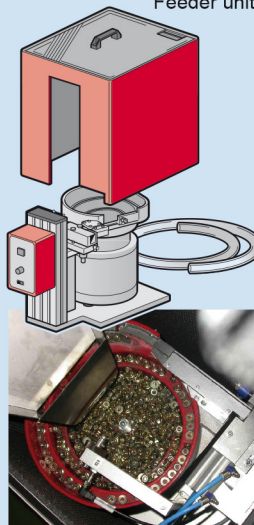

Pneumatic and electrical equipment

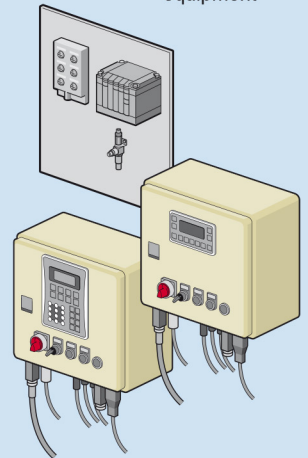

Free choice of drive

- In addition to the STÖGER pneumatic and electric range, our premium screwdrivers are designed to enable adaptation to other motors. This enables integration of your or your customers preferred unit.
- Adaption is carried out by STÖGER
- It is normally possible to continue use of the system presently in service.

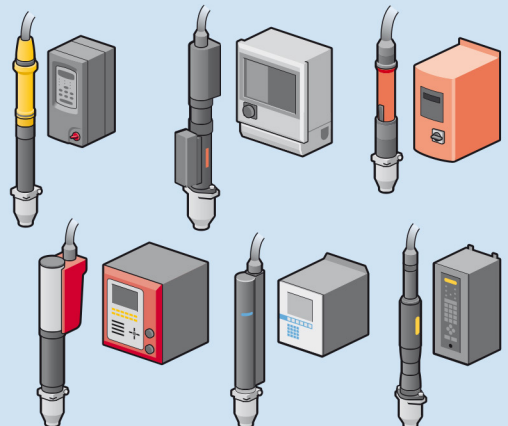

Motor adapter

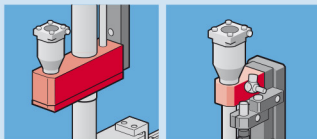

Assembling heating elements for water boilers

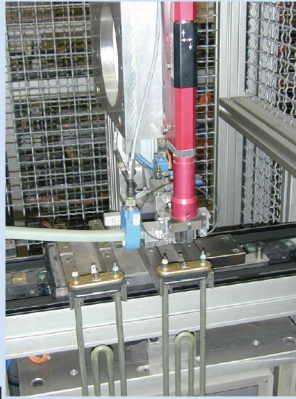

Assembling motor vehicle door trim panel

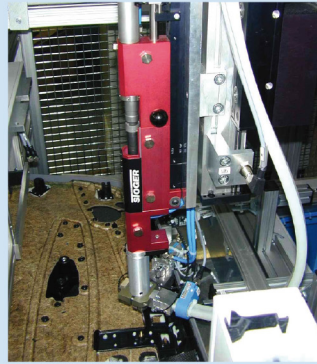

Attaching air bag assembly, vertically from below



Fitting nuts to bicycle wheel hub

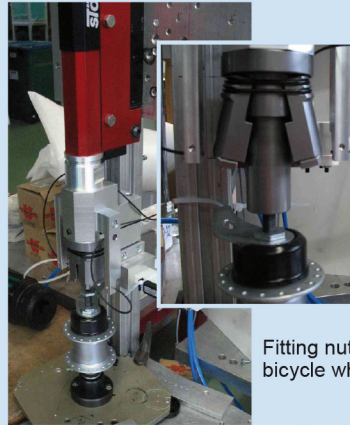

Fitting nut to drum bearing

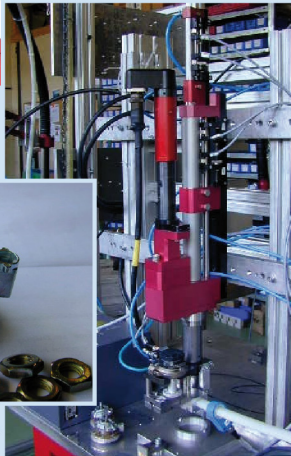

TOP 100
We are among the
100 most innovative
companies in Germany !



Lorenz Stöger being presented with
the award by Lothar Späth

OUR TURN
YOUR ADVANTAGE

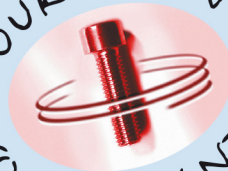

STÖGER
AUTOMATION

01.05.14



STÖGER AUTOMATION GmbH · Gewerbering am Brand 1 · D-82549 Königsdorf

+49(0)8179/99767-0

+49(0)8179/99767-50

eMail info@stoeger.com

Internet www.stoeger.com